



Report

US \$44.99

2019 Ford Transit 350 XL

110,339 mi | VIN: 1FBAX2CM8KKA53812 |

Van | 3.7L V6 F DOHC 24V | Gasoline | Rear wheel drive

CARFAX HAS THE MOST ACCIDENT & DAMAGE INFORMATION



ACCIDENT Minor Damage



Minor Moderate Severe

CARFAX VALUE \$23,260

15 Service History Records

2 Previous Owners

Types of Owners: Commercial, Lease

Last Owned in Georgia

35 Detailed Records Available

This CARFAX Vehicle History Report is based only on information supplied to CARFAX and available as of 5/8/26 at 1:13:46 PM (CDT). Other information about this vehicle, including problems, may not have been reported to CARFAX. Use this report as one important tool, along with a vehicle inspection and test drive, to make a better decision about your next used car.



Accident / Damage History

Not all accidents / issues are reported to CARFAX

Event 1

03/07/2025

Accident reported: minor damage

-Airbags did not deploy

Damage Severity Scale



Minor Moderate Severe

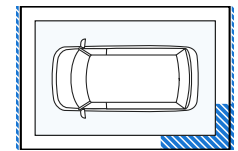

Recent Service Highlights

Key services performed in the last 12 months

Service	Comments	Date
Oil	✓ Oil and filter changed	11/10/2025
Tires	✓ Tires rotated	08/20/2025
Brakes	✓ Front brake pads replaced	11/10/2025
	✓ Front brake rotor(s) replaced	

- ✓ Rear brake pads replaced
- ✓ Rear brake rotor(s) replaced

Flashes ⓘ

✓ Antifreeze/coolant flushed/changed

08/20/2025



This car has been recently serviced. That's a good thing!

CARFAX History-Based Value Report

\$23,260

CARFAX Retail Value

History events affecting this vehicle's value

- ↑ Service History
- ↓ Minor Damage

CARFAX Additional History

Not all accidents / issues are reported to CARFAX

	👤 Owner 1	👤 Owner 2
Total Loss No total loss reported to CARFAX.	✓ No Issues Reported	✓ No Issues Reported
Structural Damage CARFAX recommends that you have this vehicle inspected by a collision repair specialist.	✓ No Issues Reported	✓ No Issues Reported
Airbag Deployment No airbag deployment reported to CARFAX.	✓ No Issues Reported	✓ No Issues Reported
Odometer Check No indication of an odometer rollback.	✓ No Issues Indicated	✓ No Issues Indicated
Accident / Damage Accident reported: 03/07/2025.	✓ No Issues Reported	Minor Damage
Manufacturer Recall No open recalls reported to CARFAX. A current list of recalls is available at Ford Motor Company.	✓ No Recalls Reported	✓ No Recalls Reported
Basic Warranty Original warranty estimated to have expired.	Warranty Expired	Warranty Expired

CARFAX Title History

CARFAX guarantees the information in this section

	👤 Owner 1	👤 Owner 2
Damage Brands Salvage Junk Rebuilt Fire Flood Hail Lemon	✓ Guaranteed No Problem	✓ Guaranteed No Problem
Odometer Brands Not Actual Mileage Exceeds Mechanical Limits	✓ Guaranteed No Problem	✓ Guaranteed No Problem



GUARANTEED - None of these title problems were reported by a U.S. state Department of Motor Vehicles (DMV). If you find that any of these title problems were reported by a DMV and not included in this report, you may qualify.
[View Terms](#) | [View Certificate](#)

CARFAX Ownership History

The number of owners is estimated

	👤 Owner 1	👤 Owner 2
Year purchased	2019	2021
Type of owner	Commercial	Lease

Estimated length of ownership	2 years	4 yrs. 11 mo.
Owned in the following states/provinces	Georgia	Georgia
Estimated miles driven per year	13,272/yr	17,182/yr
Last reported odometer reading	21,890	110,339







Detailed History

 **Owner 1**
Purchased: 2019





Low mileage! This owner drove less than the industry average of 15,000 miles per year.

Commercial Vehicle
13,272 mi/yr



Date	Mileage	Source		Comments
Not Reported		Ford Motor Company		Vehicle manufactured and shipped to original dealer
01/17/2019		Gerald Jones Lincoln Evans, GA 762-224-5232 geraldjoneslincolnaugusta.com/		Vehicle offered for sale
03/18/2019	10	Gerald Jones Lincoln Evans, GA 762-224-5232 geraldjoneslincolnaugusta.com/		Vehicle serviced
03/19/2019	15	Gerald Jones Lincoln Evans, GA 762-224-5232 geraldjoneslincolnaugusta.com/		Vehicle sold
03/19/2019		Georgia Motor Vehicle Dept.		Vehicle purchase reported - Titled or registered as commercial vehicle
04/05/2019		Georgia Motor Vehicle Dept. Augusta, GA Title #777168190952963		Vehicle purchase reported - Title issued or updated - Registration issued or renewed - Title or registration issued - First owner reported - Loan or lien reported - Vehicle color noted as White
07/24/2019	5,415	Butler Automotive Augusta, GA 706-854-0888 butlerautomotive.com		Vehicle serviced - Oil and filter changed - Tire condition and pressure checked
08/13/2019	6,320	Gerald Jones Lincoln Evans, GA 762-224-5232 geraldjoneslincolnaugusta.com/		Vehicle serviced
10/10/2019		Georgia Motor Vehicle Dept. Augusta, GA Title #777168190952963		Registration issued or renewed - Loan or lien reported - Vehicle color noted as White
03/03/2020	17,519	Butler Automotive Augusta, GA 706-854-0888 butlerautomotive.com		Vehicle serviced - Oil and filter changed - Tire condition and pressure checked - Tires rotated
07/14/2020	18,526	Butler Automotive Augusta, GA 706-854-0888 butlerautomotive.com		Vehicle serviced - Battery/charging system checked - Battery replaced

09/05/2020		Georgia Motor Vehicle Dept.		Vehicle purchase reported
11/10/2020	21,890	Butler Automotive Augusta, GA 706-854-0888 butlerautomotive.com		Vehicle serviced -Oil and filter changed -Tire condition and pressure checked
11/10/2020		Georgia Motor Vehicle Dept. Augusta, GA Title #770049207632980		Title or registration issued -Vehicle color noted as White

 **Owner 2**
Purchased: 2021 Lease Vehicle
17,182 mi/yr

Date	Mileage	Source		Comments
03/30/2021		Georgia Motor Vehicle Dept.		Vehicle purchase reported
04/05/2021		Georgia Motor Vehicle Dept. Savannah, GA Title #770071220933003		Title issued or updated - Title or registration issued - New owner reported - Titled or registered as lease vehicle - Vehicle color noted as White
05/10/2021	26,782	Butler Automotive Augusta, GA 706-854-0888 butlerautomotive.com		Vehicle serviced - Air filter replaced - Axles checked - Brakes checked - Brake calipers cleaned/serviced - Four tires balanced - Four tires mounted - Oil and filter changed - Rear brake pads replaced - Rear brake rotor(s) replaced - Tire condition and pressure checked - Tire(s) replaced
05/25/2021	26,798	Butler Automotive Augusta, GA 706-854-0888 butlerautomotive.com		Vehicle serviced - Battery/charging system checked - Battery replaced
02/15/2022		Georgia Motor Vehicle Dept. Savannah, GA Title #770071220933003		Registration issued or renewed - Titled or registered as lease vehicle - Vehicle color noted as White
06/28/2022	45,019	Butler Automotive Augusta, GA 706-854-0888 butlerautomotive.com		Vehicle serviced - Axle seal(s) replaced - Brakes checked - Brake fluid flushed/changed - Fluids checked - Four tires balanced - Four tires mounted - Front brake pads replaced - Front brake rotor(s) replaced - Rear brake caliper(s) replaced - Rear brake pads replaced - Rear brake rotor(s) replaced - Tire(s) replaced - Wiper(s) replaced
03/01/2023		Georgia Motor Vehicle Dept. Savannah, GA Title #770071220933003		Registration issued or renewed - Titled or registered as lease vehicle - Vehicle color noted as White
07/10/2023	60,894	Butler Automotive Augusta, GA 706-854-0888 butlerautomotive.com		Vehicle serviced - Brakes checked - Front brake pads replaced - Front brake rotor(s) replaced

- Oil and filter changed
- Tire condition and pressure checked
- Tires rotated

10/09/2023	66,761	Butler Automotive Augusta, GA 706-854-0888 butlerautomotive.com		Vehicle serviced -Air filter replaced -Brakes checked -Lug nut(s)/bolt(s) replaced -Oil and filter changed -Rear brake caliper(s) replaced -Rear brake pads replaced -Rear brake rotor(s) replaced -Tire condition and pressure checked
12/26/2023	70,630	Butler Automotive Augusta, GA 706-854-0888 butlerautomotive.com		Vehicle serviced -Rear brake caliper(s) replaced -Rear brake pads replaced -Rear brake rotor(s) replaced
12/30/2023		Georgia Motor Vehicle Dept. Savannah, GA Title #770071220933003		Registration issued or renewed -Titled or registered as lease vehicle -Vehicle color noted as White
03/06/2024	74,089	Butler Automotive Augusta, GA 706-854-0888 butlerautomotive.com		Vehicle serviced -Four wheel alignment performed -Ignition coil(s) replaced -Intake manifold gasket(s) replaced -Oil and filter changed -Spark plug(s) replaced -Tire condition and pressure checked -Tire(s) replaced -Two tires balanced -Two tires mounted -Two tires replaced
01/14/2025		Georgia Motor Vehicle Dept. Savannah, GA Title #770071220933003		Registration issued or renewed -Titled or registered as lease vehicle -Vehicle color noted as White

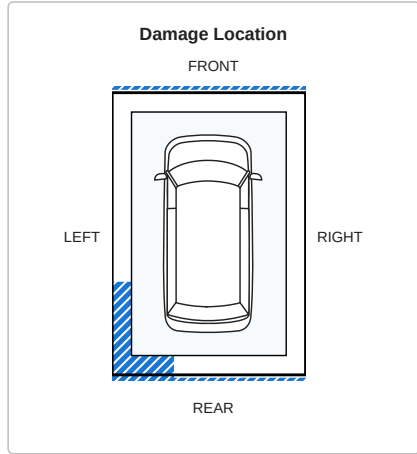
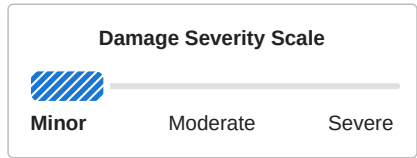

03/07/2025 Damage Report **Accident reported: minor damage**
 -Damage to left rear
 -Airbags did not deploy



CARFAX HAS THE MOST ACCIDENT & DAMAGE INFORMATION



Minor damage is usually cosmetic, including dents or scratches to the vehicle body.

08/20/2025	100,236	Jiffy Lube Evans, GA 706-869-9219 jiffylube.com/		Vehicle serviced -Maintenance inspection completed -Antifreeze/coolant flushed/changed -Oil and filter changed -Radiator repaired -Tire condition and pressure checked -Tires rotated -Wiper(s) replaced
11/10/2025	104,409	Butler Automotive Augusta, GA 706-854-0888 butlerautomotive.com		Vehicle serviced -Brakes checked -Front brake pads replaced -Front brake rotor(s) replaced -Oil and filter changed -Rear brake pads replaced -Rear brake rotor(s) replaced -Tire condition and pressure checked
01/10/2026		Georgia Motor Vehicle Dept. Savannah, GA Title #770071220933003		Registration issued or renewed -Titled or registered as lease vehicle -Vehicle color noted as White
03/11/2026		Online Listing		Vehicle offered for sale
03/20/2026	110,339	Fleet/Lease Company		Vehicle sold
03/20/2026		Auto Auction		Vehicle sold
				Millions of used vehicles are bought and sold at auction every year.
03/31/2026		Ford Motor Company		Manufacturer Customer Satisfaction issued -Program #25N17 REAR VIEW CAMERA REPLACEMENT IF REQUIRED AFTER DEALER EVALUATION Locate an authorized Ford or Lincoln dealer or call 866-436-7332 to obtain more information

Have Questions? Consumers, please visit our Help Center at www.carfax.com. Dealers or Subscribers, please visit our Help Center at www.carfaxonline.com.

Glossary

Accident Indicator

CARFAX receives information about accidents in all 50 states, the District of Columbia and Canada.

Not every accident is reported to CARFAX. As details about the accident become available, those additional details are added to the CARFAX Vehicle History Report. CARFAX recommends that you have this vehicle inspected by a qualified mechanic.

- According to the National Safety Council, Injury Facts, 2021 edition, 5% of the 276 million registered vehicles in the U.S. were involved in an accident in 2019. Over 77% of these were considered minor or moderate.
- This CARFAX Vehicle History Report is based only on information supplied to CARFAX and available as of 5/8/26 at 1:13:46 PM (CDT). Other information about this vehicle, including problems, may not have been reported to CARFAX. Use this report as one important tool, along with a vehicle inspection and test drive, to make a better decision about your next used car.

Commercial

Vehicle was registered for business purposes.

Damage Severity

Damage events result in one of the following severity levels:

- Minor: Generally, minor damage is cosmetic (including dents or scratches), may only require reconditioning, and typically does not compromise a vehicle's operation and/or safety.
- Moderate: Moderate damage may affect multiple components of the vehicle and may impair the vehicle's operation and/or safety.
- Severe: Severe damage usually affects multiple components of the vehicle and is likely to compromise the vehicle's operation and/or safety.

CARFAX recommends getting a pre-purchase inspection at a certified collision repair facility.

First Owner

When the first owner(s) obtains a title from a Department of Motor Vehicles as proof of ownership.

Ford or Lincoln Mercury Recall

The Ford Motor Company provides CARFAX with Field Service Action and recall information regarding safety, compliance and emissions programs announced since 2000 for a specific vehicle. For complete information regarding programs or concerns about this vehicle, please contact a local Ford or Lincoln Mercury

Dealer.

Lease

When someone leases a car from a dealer, the dealer actually sells the vehicle to a leasing company. The leasing company then collects payments for the vehicle from the new owner for 24, 36, 48 or more months. A leasing company can be an independent car dealer or a car manufacturer.

New Owner Reported

When a vehicle is sold to a new owner, the Title must be transferred to the new owner(s) at a Department of Motor Vehicles.

Ownership History

CARFAX defines an owner as an individual or business that possesses and uses a vehicle. Not all title transactions represent changes in ownership. To provide estimated number of owners, CARFAX proprietary technology analyzes all the events in a vehicle history. Estimated ownership is available for vehicles manufactured after 1991 and titled solely in the US including Puerto Rico. Dealers sometimes opt to take ownership of a vehicle and are required to in the following states: Maine, Massachusetts, New Jersey, Ohio, Oklahoma, Pennsylvania and South Dakota. Please consider this as you review a vehicle's estimated ownership history.

Title Issued

A state issues a title to provide a vehicle owner with proof of ownership. Each title has a unique number. Each title or registration record on a CARFAX report does not necessarily indicate a change in ownership. In Canada, a registration and bill of sale are used as proof of ownership.

[Full Glossary](#)

Follow Us:  facebook.com/CARFAX  [@CARFAXinc](https://twitter.com/CARFAXinc)  [About CARFAX](#)

CARFAX DEPENDS ON ITS SOURCES FOR THE ACCURACY AND RELIABILITY OF ITS INFORMATION. THEREFORE, NO RESPONSIBILITY IS ASSUMED BY CARFAX OR ITS AGENTS FOR ERRORS OR OMISSIONS IN THIS REPORT. CARFAX FURTHER EXPRESSLY DISCLAIMS ALL WARRANTIES, EXPRESS OR IMPLIED, INCLUDING ANY IMPLIED WARRANTIES OF MERCHANTABILITY OR FITNESS FOR A PARTICULAR PURPOSE.

© 2026 CARFAX, Inc., part of S&P Global. All rights reserved.
5/8/26 1:13:46 PM (CDT)

I have reviewed and received a copy of the CARFAX Vehicle History Report for this 2019 FORD TRANSIT vehicle (VIN: 1FBAX2CM8KKA53812), which is based on information supplied to CARFAX and available as of 5/8/26 at 2:13 PM (EDT).

Customer Signature

Date

Dealer Signature

Date