



Report

US \$44.99

2025 Lexus NX 250

25,027 mi | VIN: 2T2ADCEZ3SC005439 |

4 Door Wagon/Sport Utility | 2.5L I4 F DOHC 16V | Gasoline | All wheel drive



ACCIDENT

⚠️ Accident Reported

🛢️ Regular Oil Changes

📄 At Least 1 Open Recall

1 CARFAX 1-Owner Vehicle

🏠 Personal Lease Vehicle

🌍 Last Owned in New York

This CARFAX Vehicle History Report is based only on information supplied to CARFAX and available as of 5/8/26 at 11:27:49 AM (CDT). Other information about this vehicle, including problems, may not have been reported to CARFAX. Use this report as one important tool, along with a vehicle inspection and test drive, to make a better decision about your next used car.



Accident / Damage History

Not all accidents / issues are reported to CARFAX

Event 1

02/03/2025

Accident reported: minor damage

Damage Severity Scale

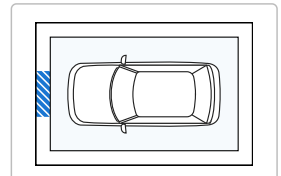
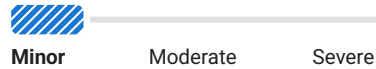

Event 2



07/28/2025

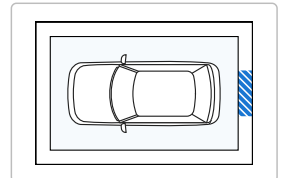

Accident reported



Recent Service Highlights

Key services performed in the last 12 months



Service	Comments	Date
 Oil	✓ Oil and filter changed	11/10/2025
 Tires	✓ Tires rotated	04/15/2026
<div style="border: 1px solid #007bff; padding: 5px; display: inline-block;">This car has been recently serviced. That's a good thing!</div>		

 Additional History Not all accidents / issues are reported to CARFAX	 Owner 1
Total Loss No total loss reported to CARFAX.	✓ No Issues Reported
Structural Damage CARFAX recommends that you have this vehicle inspected by a collision repair specialist.	✓ No Issues Reported
Airbag Deployment No airbag deployment reported to CARFAX.	✓ No Issues Reported
Odometer Check No indication of an odometer rollback.	✓ No Issues Indicated
Accident / Damage Accidents reported: 02/03/2025 and 07/28/2025.	Accident Reported
Manufacturer Recall At least 1 open recall reported. View Toyota disclosure	Recall Reported
Basic Warranty Original warranty estimated to have 25 months or 24,973 miles remaining. Confirm with dealer or vehicle manufacturer.	✓ Warranty Active

 Title History CARFAX guarantees the information in this section	 Owner 1
Damage Brands Salvage Junk Rebuilt Fire Flood Hail Lemon	✓ Guaranteed No Problem
Odometer Brands Not Actual Mileage Exceeds Mechanical Limits	✓ Guaranteed No Problem



GUARANTEED - None of these title problems were reported by a U.S. state Department of Motor Vehicles (DMV). If you find that any of these title problems were reported by a DMV and not included in this report, you may qualify. [View Terms](#) | [View Certificate](#)

 Ownership History The number of owners is estimated	 Owner 1
Year purchased	2024
Type of owner	Personal Lease
Estimated length of ownership	1 yr. 11 mo.
Owned in the following states/provinces	New York
Estimated miles driven per year	13,162/yr
Last reported odometer reading	25,027







 Detailed History

 **Owner 1**
Purchased: 2024

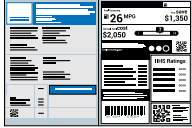
Low mileage! This owner drove less than the industry average of 15,000 miles per year.

Personal Lease Vehicle
13,162 mi/yr

Date	Mileage	Source	Comments
04/08/2024		Lexus, a Division of Toyota Motor Sales, USA, Inc.	Vehicle manufactured and shipped to original dealer Original Window Sticker (Need US VPN) 
04/20/2024	5	Prestige Lexus of Ramsey Ramsey, NJ 201-825-5200 prestigelexus.com ★ 4.7 / 5.0 282 Verified Reviews ❤️ 60 Customer Favorites	 Vehicle serviced - Pre-delivery inspection completed - Vehicle washed/detailed
05/21/2024		New York Motor Vehicle Dept. Suffern, NY	Registration issued or renewed - Titled or registered as personal lease vehicle - Passed safety inspection
05/28/2024	504	New York Inspection Station	Passed safety inspection - Emissions inspection performed
06/03/2024		New York Motor Vehicle Dept. College Station, TX	Title issued or updated - First owner reported
10/07/2024		Prestige Lexus of Ramsey Ramsey, NJ 201-825-5200 prestigelexus.com ★ 4.7 / 5.0 282 Verified Reviews ❤️ 60 Customer Favorites	 Vehicle serviced - Drivability/performance checked - Fluids checked - Oil and filter changed - Tire condition and pressure checked - Tires rotated - Vehicle washed/detailed
12/31/2024	8,359	Prestige Lexus of Ramsey Ramsey, NJ 201-825-5200 prestigelexus.com ★ 4.7 / 5.0 282 Verified Reviews ❤️ 60 Customer Favorites	 Vehicle serviced
02/03/2025		Damage Report	Accident reported: minor damage - Damage to front

Damage Severity Scale



Minor

Moderate

Severe

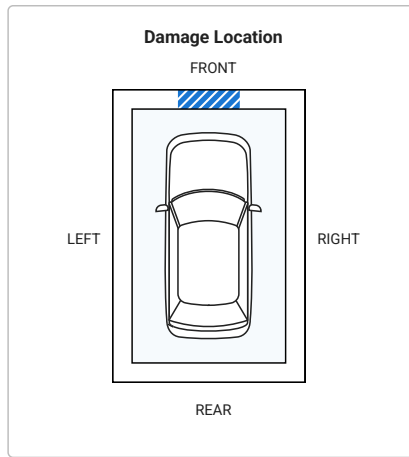

02/13/2025	9,523	Prestige Lexus of Ramsey Ramsey, NJ 201-825-5200 prestigelexus.com ★ 4.7 / 5.0 282 Verified Reviews ❤️ 60 Customer Favorites		Vehicle serviced - 10,000 mile service performed - Brakes checked - Cabin air filter replaced/cleaned - Computer reprogrammed - Drivability/performance checked - Floor mat(s) checked - Fluids checked - Maintenance reminder reset - Oil and filter changed - Tires rotated - Wipers/washers checked
03/05/2025	10,017	Prestige Lexus of Ramsey Ramsey, NJ 201-825-5200 prestigelexus.com ★ 4.7 / 5.0 282 Verified Reviews ❤️ 60 Customer Favorites		Vehicle serviced
05/31/2025	13,293	New York Inspection Station		Passed safety inspection
07/09/2025	14,594	Prestige Lexus of Ramsey Ramsey, NJ 201-825-5200 prestigelexus.com ★ 4.7 / 5.0 282 Verified Reviews ❤️ 60 Customer Favorites		Vehicle serviced - 15,000 mile service performed - Antifreeze/coolant checked - Anti-theft/keyless remote battery replaced - Brakes checked - Cooling system checked - CV boot(s) checked - Drivability/performance checked - Exhaust system checked - Floor mat(s) checked - Fluids checked - Maintenance reminder reset - Power steering checked - Steering/suspension checked - Tires rotated - Wipers/washers checked - Wiper(s) replaced
07/28/2025		Damage Report		Accident reported - Damage to rear

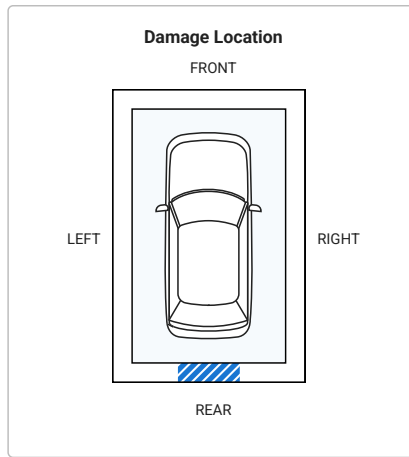

10/07/2025		New York Motor Vehicle Dept. Suffern, NY		Registration issued or renewed - Passed safety inspection
11/10/2025	19,304	Prestige Lexus of Ramsey Ramsey, NJ 201-825-5200 prestigelexus.com ★ 4.7 / 5.0 282 Verified Reviews ♥ 60 Customer Favorites		Vehicle serviced - Maintenance inspection completed - 20,000 mile service performed - Brakes checked - Computer reprogrammed - Drivability/performance checked - Floor mat(s) checked - Fluids checked - Four wheel alignment performed - Fuel system cleaned/serviced - Maintenance reminder reset - Oil and filter changed - Tires rotated - Wipers/washers checked - Wiper(s) replaced
02/13/2026	22,494	Prestige Lexus of Ramsey Ramsey, NJ 201-825-5200 prestigelexus.com ★ 4.7 / 5.0 282 Verified Reviews ♥ 60 Customer Favorites		Vehicle serviced - One tire replaced - Tire(s) balanced - Tire(s) replaced
03/18/2026		Lexus, a Division of Toyota Motor Sales, USA, Inc.		Manufacturer Safety recall issued - NHTSA #Pending - Recall #26LB02 SAFETY RECALL 26LA02 (INTERIM NOTICE 26LB02) - 2022-2025 MY NX250 & NX350, 2023-2026 MY RX350, AND MY 2024-2026 TX350 - BACKUP CAMERA IMAGE MAY APPEAR BLANK - Status: Remedy Not Yet Available + Learn more about this recall
04/15/2026	25,027	Prestige Lexus of Ramsey Ramsey, NJ 201-825-5200 prestigelexus.com ★ 4.7 / 5.0 282 Verified Reviews ♥ 60 Customer Favorites		Vehicle serviced - Maintenance inspection completed - 25,000 mile service performed - Brakes checked - Computer reprogrammed - Drivability/performance checked - Floor mat(s) checked - Fluids checked - Maintenance reminder reset - Tires rotated - Wipers/washers checked
05/02/2026		Online Listing		Vehicle offered for sale

This vehicle's oil change history, as reported to CARFAX, follows the manufacturer's recommendation. Track your service history for free at [/carfax.com/service](https://carfax.com/service).

Glossary

Accident Indicator

CARFAX receives information about accidents in all 50 states, the District of Columbia and Canada.

Not every accident is reported to CARFAX. As details about the accident become available, those additional details are added to the CARFAX Vehicle History Report. CARFAX recommends that you have this vehicle inspected by a qualified mechanic.

- According to the National Safety Council, Injury Facts, 2021 edition, 5% of the 276 million registered vehicles in the U.S. were involved in an accident in 2019. Over 77% of these were considered minor or moderate.
- This CARFAX Vehicle History Report is based only on information supplied to CARFAX and available as of 5/8/26 at 11:27:49 AM (CDT). Other information about this vehicle, including problems, may not have been reported to CARFAX. Use this report as one important tool, along with a vehicle inspection and test drive, to make a better decision about your next used car.

CARFAX Well Maintained - Regular Oil Changes

CARFAX identifies a "Well Maintained - Regular Oil Change" vehicle as having a regular oil change history when all its recommended oil changes, based on the vehicle's maintenance schedule, have been reported to CARFAX. CARFAX uses the manufacturer's schedule and assumes normal driving conditions. When an oil change schedule is not available, CARFAX may analyze reported service events to determine what is typical for the same make and model vehicle. Dealers and service shops may publish different recommended service schedules.

Damage Severity

Damage events result in one of the following severity levels:

- Minor: Generally, minor damage is cosmetic (including dents or scratches), may only require reconditioning, and typically does not compromise a vehicle's operation and/or safety.
- Moderate: Moderate damage may affect multiple components of the vehicle and may impair the vehicle's operation and/or safety.
- Severe: Severe damage usually affects multiple components of the vehicle and is likely to compromise the vehicle's operation and/or safety.

CARFAX recommends getting a pre-purchase inspection at a certified collision repair facility.

First Owner

When the first owner(s) obtains a title from a Department of Motor Vehicles as proof of ownership.

Lexus Recall / Service Campaign

Portions of this report have been included under license from Toyota Motor North America, Inc. ("TOYOTA"), License Agreement TMS1013. This data applies only to vehicle marketed or originally sold in Mexico and the United States of America, including Guam, Saipan, American Samoa, Puerto Rico, the U.S. Virgin Islands and the other United States territories and protectorates with currently open safety or emissions recalls, or service campaigns. While TOYOTA provides data to Carfax Inc. on a regular basis, this report may not include very recent activity. For the manufacturer's most current information on recall/campaign activity for any Toyota, Lexus or Scion brand vehicle, you must go to <http://toyota.com/recall> or <http://lexus.com/recall>.

Manufacturer Recall



Automobile manufacturers issue recall notices to inform vehicle owners of a safety defect or failure to meet minimum federal safety or emissions standards. Manufacturer recalls are repaired at no cost to the customer.

Ownership History

CARFAX defines an owner as an individual or business that possesses and uses a vehicle. Not all title transactions represent changes in ownership. To provide estimated number of owners, CARFAX proprietary technology analyzes all the events in a vehicle history. Estimated ownership is available for vehicles manufactured after 1991 and titled solely in the US including Puerto Rico. Dealers sometimes opt to take ownership of a vehicle and are required to in the following states: Maine, Massachusetts, New Jersey, Ohio, Oklahoma, Pennsylvania and South Dakota. Please consider this as you review a vehicle's estimated ownership history.

Title Issued

A state issues a title to provide a vehicle owner with proof of ownership. Each title has a unique number. Each title or registration record on a CARFAX report does not necessarily indicate a change in ownership. In Canada, a registration and bill of sale are used as proof of ownership.

Follow Us:  facebook.com/CARFAX  [@CARFAXinc](https://twitter.com/CARFAXinc)  [About CARFAX](#)

CARFAX DEPENDS ON ITS SOURCES FOR THE ACCURACY AND RELIABILITY OF ITS INFORMATION. THEREFORE, NO RESPONSIBILITY IS ASSUMED BY CARFAX OR ITS AGENTS FOR ERRORS OR OMISSIONS IN THIS REPORT. CARFAX FURTHER EXPRESSLY DISCLAIMS ALL WARRANTIES, EXPRESS OR IMPLIED, INCLUDING ANY IMPLIED WARRANTIES OF MERCHANTABILITY OR FITNESS FOR A PARTICULAR PURPOSE.

SYSTEMATIC RETRIEVAL OF THE CONTENT OR OTHER DATA FROM THIS SITE TO CREATE OR COMPILE, DIRECTLY OR INDIRECTLY, IN WHOLE OR IN PART, A COLLECTION, COMPILATION, DATABASE OR DIRECTORY WITHOUT THE EXPRESS WRITTEN PERMISSION OF CARFAX IS STRICTLY PROHIBITED. BY USING THE CARFAX VEHICLE HISTORY REPORT YOU AGREE TO THE CARFAX TERMS OF USE AND PRIVACY STATEMENT.

© 2026 CARFAX, Inc., part of S&P Global. All rights reserved.
5/8/26 11:27:49 AM (CDT)