



Report

US \$44.99

2020 Mercedes-Benz Sprinter 3500XD

143,059 mi | VIN: W1W8ED3Y2LP248439 |

Cargo Van | 3.0L V6 F DOHC 24V | Diesel | Rear wheel drive

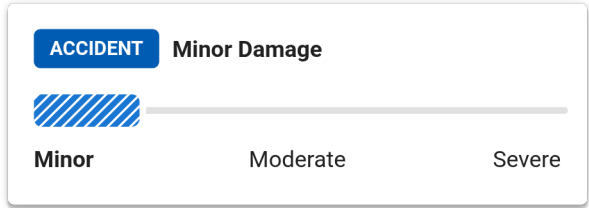

Regular Oil Changes

CARFAX 1-Owner Vehicle

Commercial Vehicle

Last Owned in New York

24 Detailed Records Available

This CARFAX Vehicle History Report is based only on information supplied to CARFAX and available as of 5/8/26 at 12:49:32 PM (CDT). Other information about this vehicle, including problems, may not have been reported to CARFAX. Use this report as one important tool, along with a vehicle inspection and test drive, to make a better decision about your next used car.



Accident / Damage History

Not all accidents / issues are reported to CARFAX

Event 1

05/05/2021

Accident reported: minor damage with another motor vehicle

Damage Severity Scale

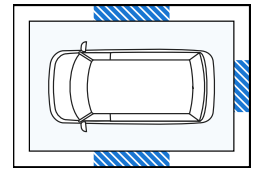
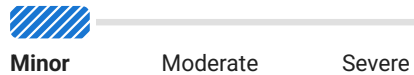

Event 2

10/03/2023

Damage reported: very minor damage

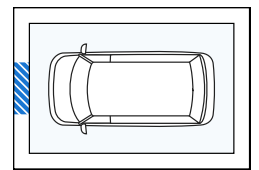
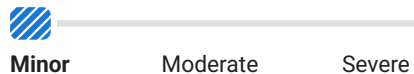

Damage Severity Scale



Recent Service Highlights



Key services performed in the last 12 months

Service	Comments	Date
 Oil	✓ Oil and filter changed	08/29/2025
This car has been recently serviced. That's a good thing!		

 Additional History Not all accidents / issues are reported to CARFAX	 Owner 1
Total Loss No total loss reported to CARFAX.	<input checked="" type="checkbox"/> No Issues Reported
Structural Damage CARFAX recommends that you have this vehicle inspected by a collision repair specialist.	<input checked="" type="checkbox"/> No Issues Reported
Airbag Deployment No airbag deployment reported to CARFAX.	<input checked="" type="checkbox"/> No Issues Reported
Odometer Check No indication of an odometer rollback.	<input checked="" type="checkbox"/> No Issues Indicated
Accident / Damage Accident reported: 05/05/2021 . Damage reported: 10/03/2023.	Minor Damage
Manufacturer Recall No open recalls reported to CARFAX.	<input checked="" type="checkbox"/> No Recalls Reported
Basic Warranty Original warranty estimated to have expired.	Warranty Expired





 Title History CARFAX guarantees the information in this section	 Owner 1
Damage Brands Salvage Junk Rebuilt Fire Flood Hail Lemon	<input checked="" type="checkbox"/> Guaranteed No Problem
Odometer Brands Not Actual Mileage Exceeds Mechanical Limits	<input checked="" type="checkbox"/> Guaranteed No Problem

GUARANTEED - None of these title problems were reported by a U.S. state Department of Motor Vehicles (DMV). If you find that any of these title problems were reported by a DMV and not included in this report, you may qualify.
[View Terms](#) | [View Certificate](#)

 Ownership History The number of owners is estimated	 Owner 1
Year purchased	2020
Type of owner	Commercial
Estimated length of ownership	5 yrs. 5 mo.
Owned in the following states/provinces	New York
Estimated miles driven per year	29,203/yr
Last reported odometer reading	143,059





Detailed History

Date	Mileage	Source	Comments
09/08/2020	3	Mercedes-Benz of Smithtown Saint James, NY 631-265-2204 mbofsmithtown.com ★ 4.7 / 5.0 251 Verified Reviews ♥ 723 Customer Favorites	 Vehicle serviced - Maintenance inspection completed
10/06/2020		New York Motor Vehicle Dept. Medford, NY	Registration issued or renewed - Titled or registered as commercial vehicle - Passed safety inspection
10/08/2020	7	Mercedes-Benz of Smithtown Saint James, NY 631-265-2204 mbofsmithtown.com ★ 4.7 / 5.0 251 Verified Reviews ♥ 723 Customer Favorites	 Vehicle serviced - Maintenance inspection completed - Brakes checked - Emissions or safety inspection performed - Vehicle washed/detailed
11/09/2020		New York Motor Vehicle Dept. Medford, NY	Title issued or updated - First owner reported - Loan or lien reported - Titled or registered as commercial vehicle
11/28/2020	1,435	Mercedes-Benz of Smithtown Saint James, NY 631-265-2204 mbofsmithtown.com ★ 4.7 / 5.0 251 Verified Reviews ♥ 723 Customer Favorites	 Vehicle serviced - Maintenance inspection completed - Electrical system checked
04/23/2021	12,186	Mercedes-Benz of Smithtown Saint James, NY 631-265-2204 mbofsmithtown.com ★ 4.7 / 5.0 251 Verified Reviews ♥ 723 Customer Favorites	 Vehicle serviced - Maintenance inspection completed - Oil and filter changed

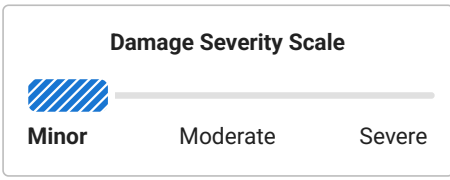
05/05/2021 Damage Report **Accident reported: minor damage with another motor vehicle**
 - Damage to rear
 - Damage to left side
 - Damage to right side

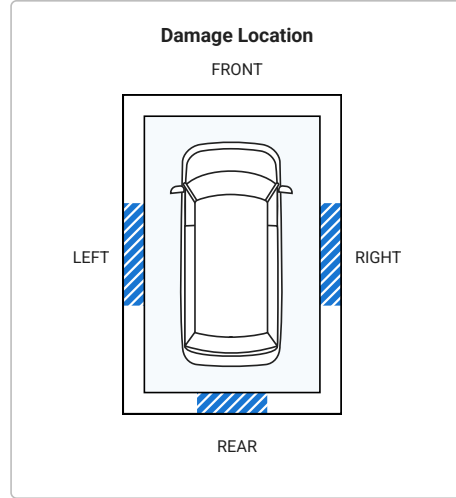



Minor damage is usually cosmetic, including dents or scratches to the vehicle body.

12/21/2021 33,106 Mercedes-Benz of Smithtown
Saint James, NY
631-265-2204
mbofsmithtown.com
★ 4.7 / 5.0 251 Verified Reviews
♥ 723 Customer Favorites



Vehicle serviced

- Maintenance inspection completed
- Recommended maintenance performed
- Alignment checked
- Brakes checked
- Brake fluid flushed/changed
- Cabin air filter replaced/cleaned
- Four wheel alignment performed
- Front brake rotor(s) replaced
- Fuel filter replaced
- Oil and filter changed
- Rear brake rotor(s) replaced
- Tires rotated
- Transmission fluid changed
- Wipers/washers checked

06/09/2022 49,732 Mercedes-Benz of Smithtown
Saint James, NY
631-265-2204
mbofsmithtown.com
★ 4.7 / 5.0 251 Verified Reviews
♥ 723 Customer Favorites



Vehicle serviced

- Maintenance inspection completed
- Recommended maintenance performed
- Air filter checked
- Alignment performed
- Fuel filter replaced
- Oil and filter changed
- Power steering checked
- Tire condition and pressure checked
- Tire(s) balanced
- Tire(s) mounted
- Transmission checked

07/08/2022 Mercedes-Benz of Smithtown
Saint James, NY
631-265-2204
mbofsmithtown.com
★ 4.7 / 5.0 251 Verified Reviews
♥ 723 Customer Favorites



Vehicle serviced

- Maintenance inspection completed
- Fuel filter replaced
- Oil and filter changed

08/08/2022 New York
Motor Vehicle Dept.
Medford, NY

Registration issued or renewed

- Titled or registered as commercial vehicle
- Passed safety inspection

10/15/2022 60,692 Mercedes-Benz of Smithtown
Saint James, NY
631-265-2204
mbofsmithtown.com
★ 4.7 / 5.0 251 Verified Reviews
♥ 723 Customer Favorites



Vehicle serviced

- Maintenance inspection completed
- Recommended maintenance performed
- Air filter checked
- EGR valve replaced
- Electrical system checked
- Engine checked
- Front brake pads replaced
- Front brake rotor(s) replaced
- Fuel filter replaced
- Oil and filter changed

-Rear brake pads replaced

12/31/2022

68,275

Mercedes-Benz of Smithtown
Saint James, NY
631-265-2204
mbofsmithtown.com

★ 4.7 / 5.0 251 Verified Reviews
♥ 723 Customer Favorites



Vehicle serviced

- Maintenance inspection completed
- EGR system checked
- EGR valve replaced
- Electrical system checked
- Engine checked
- Emissions or safety inspection performed

03/17/2023

75,711

Mercedes-Benz of Smithtown
Saint James, NY
631-265-2204
mbofsmithtown.com

★ 4.7 / 5.0 251 Verified Reviews
♥ 723 Customer Favorites



Vehicle serviced

- Maintenance inspection completed
- Alignment performed
- Electrical system checked
- Tire condition and pressure checked

07/19/2023

85,958

Mercedes-Benz of Smithtown
Saint James, NY
631-265-2204
mbofsmithtown.com

★ 4.7 / 5.0 251 Verified Reviews
♥ 723 Customer Favorites



Vehicle serviced

- Maintenance inspection completed
- Recommended maintenance performed
- Alignment performed
- Brakes checked
- Brake fluid flushed/changed
- Cabin air filter replaced/cleaned
- Fuel filter replaced
- Oil and filter changed
- Serpentine belt replaced
- Tires rotated
- Transmission fluid changed

10/03/2023

Damage Report

Damage reported: very minor damage
- Damage to front

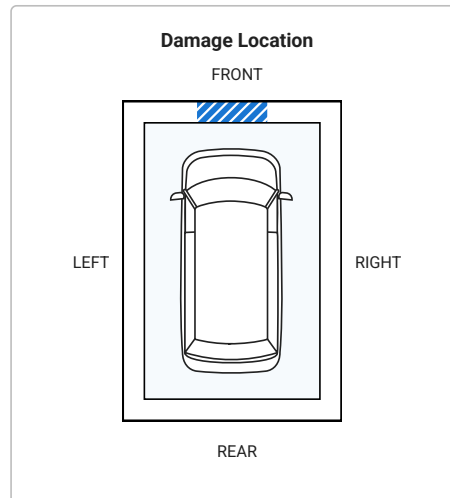
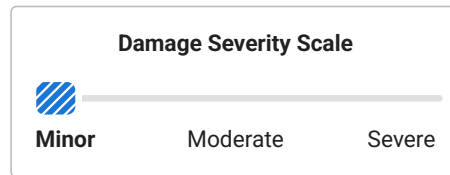

Minor damage is usually cosmetic, including dents or scratches to the vehicle body.

02/01/2024

97,846

Brakes Inc.
Port Jefferson Station, NY
631-928-1700

★ 5.0 / 5.0 80 Verified Reviews
♥ 17 Customer Favorites





Vehicle serviced

02/01/2024

New York
Inspection Station

Passed safety inspection

- Passed emissions inspection

04/17/2024	102,940	Mercedes-Benz of Smithtown Saint James, NY 631-265-2204 mbofsmithtown.com ★ 4.7 / 5.0 251 Verified Reviews ♥ 723 Customer Favorites		Vehicle serviced - Maintenance inspection completed - Recommended maintenance performed - Brakes checked - Drivability/performance checked - Front brake pads replaced - Front brake rotor(s) replaced - Fuel filter replaced - Oil and filter changed - Rear brake pads replaced - Rear brake rotor(s) replaced - Transmission fluid changed
07/15/2024		New York Motor Vehicle Dept. Medford, NY		Registration issued or renewed - Titled or registered as commercial vehicle - Passed safety inspection
12/27/2024	123,125	Mercedes-Benz of Smithtown Saint James, NY 631-265-2204 mbofsmithtown.com ★ 4.7 / 5.0 251 Verified Reviews ♥ 723 Customer Favorites		Vehicle serviced - Maintenance inspection completed - Recommended maintenance performed - Air filter checked - Brake fluid flushed/changed - Fuel filter replaced - Oil and filter changed - Tail light assembly replaced - Transmission fluid changed - Wiper(s) replaced
03/22/2025	130,804	New York Inspection Station		Passed safety inspection
08/29/2025	143,059	Mark's Auto Repair West Islip, NY 631-303-3187 marks-auto-repair.com/ ★ 4.8 / 5.0 18 Verified Reviews ♥ 476 Customer Favorites		Vehicle serviced - Fuel filter replaced - Oil and filter changed
03/30/2026		Mercedes-Benz of Smithtown Saint James, NY 631-265-2204 mbofsmithtown.com ★ 4.7 / 5.0 251 Verified Reviews ♥ 723 Customer Favorites		Vehicle offered for sale

This vehicle's oil change history, as reported to CARFAX, follows the manufacturer's recommendation. Track your service history for free at [/carfax.com/service](https://carfax.com/service).

Have Questions? Please visit our Help Center at [www./carfax.com](https://www.carfax.com).

Glossary

Accident Indicator

CARFAX receives information about accidents in all 50 states, the District of Columbia and Canada.

Not every accident is reported to CARFAX. As details about the accident become available, those additional details are added to the CARFAX Vehicle History Report. CARFAX recommends that you have this vehicle inspected by a qualified mechanic.

- According to the National Safety Council, Injury Facts, 2021 edition, 5% of the 276 million registered vehicles in the U.S. were involved in an accident in 2019. Over 77% of these were considered minor or moderate.
- This CARFAX Vehicle History Report is based only on information supplied to CARFAX and available as of 5/8/26 at 12:49:32 PM (CDT). Other information about this vehicle, including problems, may not have been reported to CARFAX. Use this report as one important tool, along with a vehicle inspection and test drive, to make a better decision about your next used car.

CARFAX Well Maintained - Regular Oil Changes

CARFAX identifies a "Well Maintained - Regular Oil Change" vehicle as having a regular oil change history when all its recommended oil changes, based on the vehicle's maintenance schedule, have been reported to CARFAX. CARFAX uses the manufacturer's schedule and assumes normal driving conditions. When an oil change schedule is not available, CARFAX may analyze reported service events to determine what is typical for the same make and model vehicle. Dealers and service shops may publish different recommended service schedules.

Commercial

Vehicle was registered for business purposes.

Damage Indicator

Damage can be a result of many different types of events. Examples include contact with objects (other cars, trees, traffic signs, road debris, etc), vandalism, or weather-related events. Not every damage event is reported to CARFAX. As details about the damage event become available, those additional details are added to the CARFAX Vehicle History Report. CARFAX recommends that you have this vehicle inspected by a qualified mechanic.

- This CARFAX Vehicle History Report is based only on information supplied to CARFAX and available as of 5/8/26 at 12:49:32 PM (CDT). Other information about this vehicle, including problems, may not have been reported to CARFAX. Use this report as one important tool, along with a vehicle inspection and test drive, to make a better decision about your next used car.

Damage Severity

Damage events result in one of the following severity levels:

- Minor: Generally, minor damage is cosmetic (including dents or scratches), may only require reconditioning, and typically does not compromise a vehicle's operation and/or safety.
- Moderate: Moderate damage may affect multiple components of the vehicle and may impair the vehicle's operation and/or safety.
- Severe: Severe damage usually affects multiple components of the vehicle and is likely to compromise the vehicle's operation and/or safety.

CARFAX recommends getting a pre-purchase inspection at a certified collision repair facility.

First Owner



When the first owner(s) obtains a title from a Department of Motor Vehicles as proof of ownership.

Ownership History

CARFAX defines an owner as an individual or business that possesses and uses a vehicle. Not all title transactions represent changes in ownership. To provide estimated number of owners, CARFAX proprietary technology analyzes all the events in a vehicle history. Estimated ownership is available for vehicles manufactured after 1991 and titled solely in the US including Puerto Rico. Dealers sometimes opt to take ownership of a vehicle and are required to in the following states: Maine, Massachusetts, New Jersey, Ohio, Oklahoma, Pennsylvania and South Dakota. Please consider this as you review a vehicle's estimated ownership history.

Title Issued

A state issues a title to provide a vehicle owner with proof of ownership. Each title has a unique number. Each title or registration record on a CARFAX report does not necessarily indicate a change in ownership. In Canada, a registration and bill of sale are used as proof of ownership.

Follow Us:  facebook.com/CARFAX  [@CARFAXinc](https://twitter.com/CARFAXinc)  [About CARFAX](#)

CARFAX DEPENDS ON ITS SOURCES FOR THE ACCURACY AND RELIABILITY OF ITS INFORMATION. THEREFORE, NO RESPONSIBILITY IS ASSUMED BY CARFAX OR ITS AGENTS FOR ERRORS OR OMISSIONS IN THIS REPORT. CARFAX FURTHER EXPRESSLY DISCLAIMS ALL WARRANTIES, EXPRESS OR IMPLIED, INCLUDING ANY IMPLIED WARRANTIES OF MERCHANTABILITY OR FITNESS FOR A PARTICULAR PURPOSE.

SYSTEMATIC RETRIEVAL OF THE CONTENT OR OTHER DATA FROM THIS SITE TO CREATE OR COMPILE, DIRECTLY OR INDIRECTLY, IN WHOLE OR IN PART, A COLLECTION, COMPILATION, DATABASE OR DIRECTORY WITHOUT THE EXPRESS WRITTEN PERMISSION OF CARFAX IS STRICTLY PROHIBITED. BY USING THE CARFAX VEHICLE HISTORY REPORT YOU AGREE TO THE CARFAX TERMS OF USE AND PRIVACY STATEMENT.

© 2026 CARFAX, Inc., part of S&P Global. All rights reserved.
5/8/26 12:49:32 PM (CDT)