



Report

US \$44.99

2023 Audi A7 Quattro Prestige 55 Tfsi

29,329 mi | VIN: WAUV2BF2XPN022070 |

Hatchback 4 DR | 3.0L V6 F DOHC 24V | Gasoline | All wheel drive

CARFAX HAS THE MOST ACCIDENT & DAMAGE INFORMATION



DAMAGE

Minor to Moderate Damage



CARFAX VALUE \$49,530

GOOD RELIABILITY



11 Service History Records

1 CARFAX 1-Owner Vehicle

Personal Lease Vehicle

Last Owned in New Jersey

20 Detailed Records Available

This CARFAX Vehicle History Report is based only on information supplied to CARFAX and available as of 5/8/26 at 11:50:21 AM (CDT). Other information about this vehicle, including problems, may not have been reported to CARFAX. Use this report as one important tool, along with a vehicle inspection and test drive, to make a better decision about your next used car.



Accident / Damage History

Not all accidents / issues are reported to CARFAX

Event 1

06/29/2023

Damage reported: minor damage

Damage Severity Scale

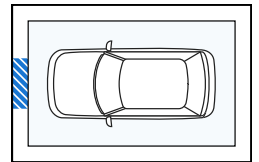
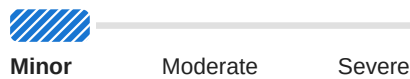

Event 2

05/22/2024

Damage reported: minor to moderate damage

Damage Severity Scale

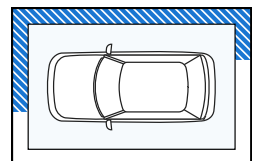

Event 3

06/26/2025

Damage reported: minor damage

Damage Severity Scale



Minor

Moderate

Severe

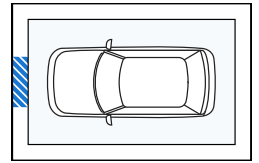

History-Based Value Report

\$49,530

CARFAX Retail Value

History events affecting this vehicle's value

- 1-Owner Vehicle
- Service History
- Personal Vehicle
- Damage



Reliability Forecast

Based on 2023 Audi A7 Quattro Prestige 55 Tfsi with similar mileage

3-Year Reliability Forecast



Good news! This vehicle is expected to have average risk of repair and low repair costs.



What makes this vehicle have good reliability?

- Low Repair Cost**
\$270 avg per year
- Average Likelihood of Repair**



Additional History

Not all accidents / issues are reported to CARFAX

Owner 1

Total Loss
No total loss reported to CARFAX.

No Issues Reported

Structural Damage
CARFAX recommends that you have this vehicle inspected by a collision repair specialist.

No Issues Reported

Airbag Deployment
No airbag deployment reported to CARFAX.

No Issues Reported

Odometer Check
No indication of an odometer rollback.

No Issues Indicated

Accident / Damage
Damage reported: 06/29/2023, 05/22/2024, and 06/26/2025.

Damage Reported

Manufacturer Recall
No open recalls reported to CARFAX.

No Recalls Reported

Basic Warranty
Original warranty estimated to have 9 months or 20,671 miles remaining. Confirm with dealer or vehicle manufacturer.

Warranty Active



Title History

CARFAX guarantees the information in this section

Owner 1

Damage Brands

Salvage | Junk | Rebuilt | Fire | Flood | Hail | Lemon

Guaranteed No Problem

Odometer Brands

Not Actual Mileage | Exceeds Mechanical Limits

Guaranteed No Problem



GUARANTEED - None of these title problems were reported by a U.S. state Department of Motor Vehicles (DMV). If you find that any of these title problems were reported by a DMV and not included in this report, you may qualify. [View Terms](#) | [View Certificate](#)



Ownership History

The number of owners is estimated

Owner 1

Year purchased

2023

Type of owner

Personal Lease

Estimated length of ownership

3 yrs. 2 mo.

Owned in the following states/provinces

New Jersey

Estimated miles driven per year

11,648/yr

Last reported odometer reading

29,329



Detailed History

Owner 1
Purchased: 2023







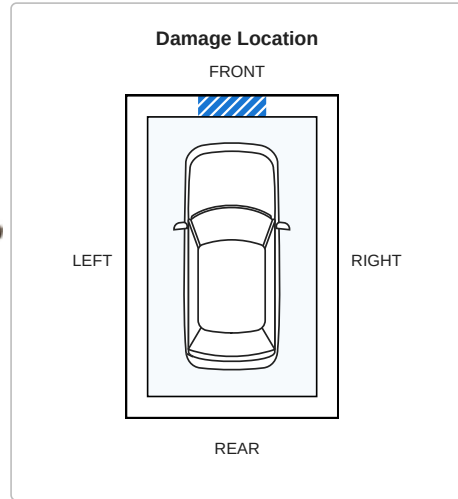
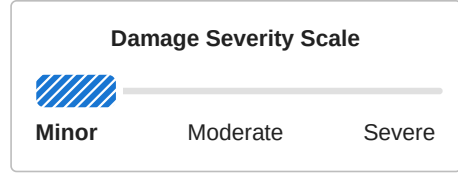

Low mileage! This owner drove less than the industry average of 15,000 miles per year.

Personal Lease Vehicle
11,648 mi/yr

Date	Mileage	Source	Comments
Not Reported		NICB	Vehicle manufactured and shipped to original dealer
12/23/2022	12	Inspection Station	Exempt from emissions inspection
12/26/2022		The Warehouse Conshohocken Conshohocken, PA 484-690-2590 mmcoauto.com/the-warehouse-conshohocken	Vehicle serviced -Pre-delivery inspection completed -Emissions or safety inspection performed -Nitrogen fill tires -Tire condition and pressure checked
01/10/2023		Audi Wynnewood Wynnewood, PA 610-649-3200 audiwynnewood.com	Vehicle sold
02/01/2023		New Jersey Motor Vehicle Dept. Blackwood, NJ Title #WT20230320169	Title issued or updated -Registration issued or renewed -First owner reported -Titled or registered as personal lease vehicle -Vehicle color noted as Black
06/17/2023	5,622	Audi Turnersville Blackwood, NJ 888-378-1019 auditurnersville.com	Vehicle serviced -Maintenance inspection completed -One tire replaced -Vehicle washed/detailed
06/29/2023		Damage Report	Damage reported: minor damage -Damage to front

CARFAX HAS THE MOST ACCIDENT & DAMAGE INFORMATION



07/31/2023	5,792	Audi Turnersville Blackwood, NJ 888-378-1019 auditurnersville.com		Vehicle serviced -Body electrical system checked
08/22/2023	6,184	Audi Turnersville Blackwood, NJ 888-378-1019 auditurnersville.com		Vehicle serviced -One tire replaced
11/15/2023	9,644	Audi Turnersville Blackwood, NJ 888-378-1019 auditurnersville.com		Vehicle serviced -Maintenance inspection completed -Oil and filter changed -Tire condition and pressure checked -Vehicle washed/detailed
02/22/2024	12,048	Audi Turnersville Blackwood, NJ 888-378-1019 auditurnersville.com		Vehicle serviced -Maintenance inspection completed -10,000 mile service performed -Glass checked -Vehicle washed/detailed
05/22/2024		Damage Report		Damage reported: minor to moderate damage -Damage to front -Damage to right side -Damage to right front -Damage to right rear

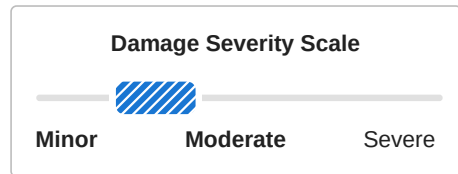

CARFAX HAS THE MOST ACCIDENT & DAMAGE INFORMATION



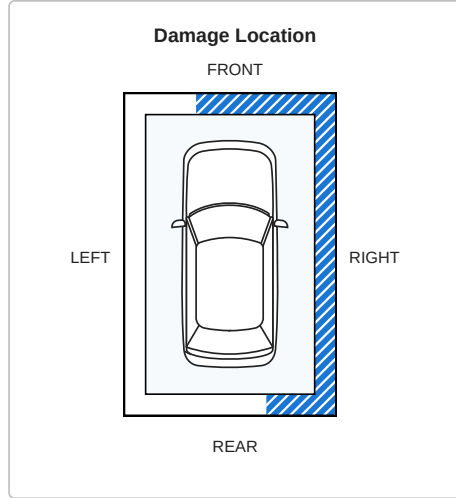

05/29/2024

Caliber Auto Glass
Lewisville, TX
888-461-0010
caliber.com/services/auto-glass



Vehicle serviced
-Glass repaired

06/14/2024

15,626

Tire Corral
Grenloch, NJ
856-227-0200



Vehicle serviced
-Alignment checked
-Alignment performed
-Tire pressure monitoring system reset

09/30/2024

20,072

Audi Turnersville
Blackwood, NJ
888-378-1019
auditurnersville.com



Vehicle serviced
-Inspection performed
-Alignment checked
-Tire checked
-Maintenance inspection completed
-20,000 mile service performed
-One tire replaced
-Vehicle washed/detailed

[View the complete inspection report](#)

12/31/2024

25,853

Audi Turnersville
Blackwood, NJ
888-378-1019
auditurnersville.com



Vehicle serviced
-Maintenance inspection completed
-One tire replaced
-Vehicle washed/detailed

06/26/2025

Damage Report

Damage reported: minor damage
-Damage to front

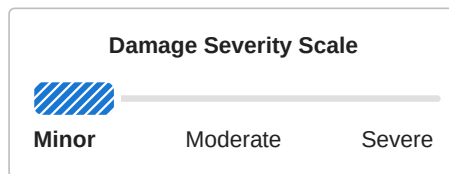

CARFAX HAS THE MOST ACCIDENT & DAMAGE INFORMATION

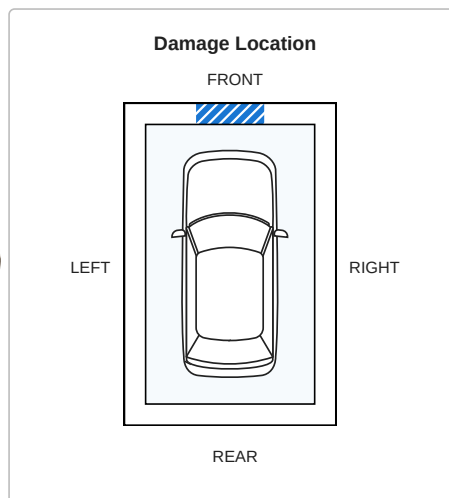

08/08/2025 29,329 Audi Fort Washington
Willow Grove, PA
215-938-0600
<https://audifortwashington.com>



Vehicle serviced
-Maintenance inspection completed
-Alignment checked
-Alternator replaced
-Tire condition and pressure checked

04/23/2026 Online Listing

Vehicle offered for sale

05/08/2026 Audi

Connect Service available with subscription

Connect offers services to enhance navigation, infotainment, and peace of mind

[Learn more](#)

Have Questions? Consumers, please visit our Help Center at www.carfax.com. Dealers or Subscribers, please visit our Help Center at www.carfaxonline.com.



Glossary

Damage Indicator

Damage can be a result of many different types of events. Examples include contact with objects (other cars, trees, traffic signs, road debris, etc), vandalism, or weather-related events. Not every damage event is reported to CARFAX. As details about the damage event become available, those additional details are added to the CARFAX Vehicle History Report. CARFAX recommends that you have this vehicle inspected by a qualified mechanic.

- This CARFAX Vehicle History Report is based only on information supplied to CARFAX and available as of 5/8/26 at 11:50:21 AM (CDT). Other information about this vehicle, including problems, may not have been reported to CARFAX. Use this report as one important tool, along with a vehicle inspection and test drive, to make a better decision about your next used car.

Damage Severity

Damage events result in one of the following severity levels:

- Minor: Generally, minor damage is cosmetic (including dents or scratches), may only require reconditioning, and typically does not compromise a vehicle's operation and/or safety.
- Moderate: Moderate damage may affect multiple components of the vehicle and may impair the vehicle's operation and/or safety.
- Severe: Severe damage usually affects multiple components of the vehicle and is likely to compromise the vehicle's operation and/or safety.

CARFAX recommends getting a pre-purchase inspection at a certified collision repair facility.

First Owner

When the first owner(s) obtains a title from a Department of Motor Vehicles as proof of ownership.

Ownership History

CARFAX defines an owner as an individual or business that possesses and uses a vehicle. Not all title transactions represent changes in ownership. To provide estimated number of owners, CARFAX proprietary technology analyzes all the events in a vehicle history. Estimated ownership is available for vehicles manufactured after 1991 and titled solely in the US including Puerto Rico. Dealers sometimes opt to take ownership of a vehicle and are required to in the following states: Maine, Massachusetts, New Jersey, Ohio, Oklahoma, Pennsylvania and South Dakota. Please consider this as you review a vehicle's estimated ownership history.

Reliability Forecast

The CARFAX 3-Year Reliability Forecast predicts the likelihood of repairs for a vehicle over the next three years. This forecast is based on vehicles of the same year, make, and model with similar mileage, damage, service history, and other factors, and assumes an average of 15,000 miles driven per year. Repairs are separate from regular maintenance, such as oil changes. Some of the repairs predicted may be covered under warranty. The 3-Year Reliability Forecast is based on data reported to Carfax and is only a prediction, not a guarantee.

Title Issued

A state issues a title to provide a vehicle owner with proof of ownership. Each title has a unique number. Each title or registration record on a CARFAX report does not necessarily indicate a change in ownership. In Canada, a registration and bill of sale are used as proof of ownership.

[Full Glossary](#)

Follow Us:



facebook.com/CARFAX



[@CARFAXinc](https://twitter.com/CARFAXinc)



[About CARFAX](#)

CARFAX DEPENDS ON ITS SOURCES FOR THE ACCURACY AND RELIABILITY OF ITS INFORMATION. THEREFORE, NO RESPONSIBILITY IS ASSUMED BY CARFAX OR ITS AGENTS FOR ERRORS OR OMISSIONS IN THIS REPORT. CARFAX FURTHER EXPRESSLY DISCLAIMS ALL WARRANTIES, EXPRESS OR IMPLIED, INCLUDING ANY IMPLIED WARRANTIES OF MERCHANTABILITY OR FITNESS FOR A PARTICULAR PURPOSE.

© 2026 CARFAX, Inc., part of S&P Global. All rights reserved.
5/8/26 11:50:21 AM (CDT)

I have reviewed and received a copy of the CARFAX Vehicle History Report for this 2023 AUDI A7 vehicle (VIN: WAUV2BF2XPN022070), which is based on information supplied to CARFAX and available as of 5/8/26 at 12:50 PM (EDT).

Customer Signature

Date

Dealer Signature

Date